

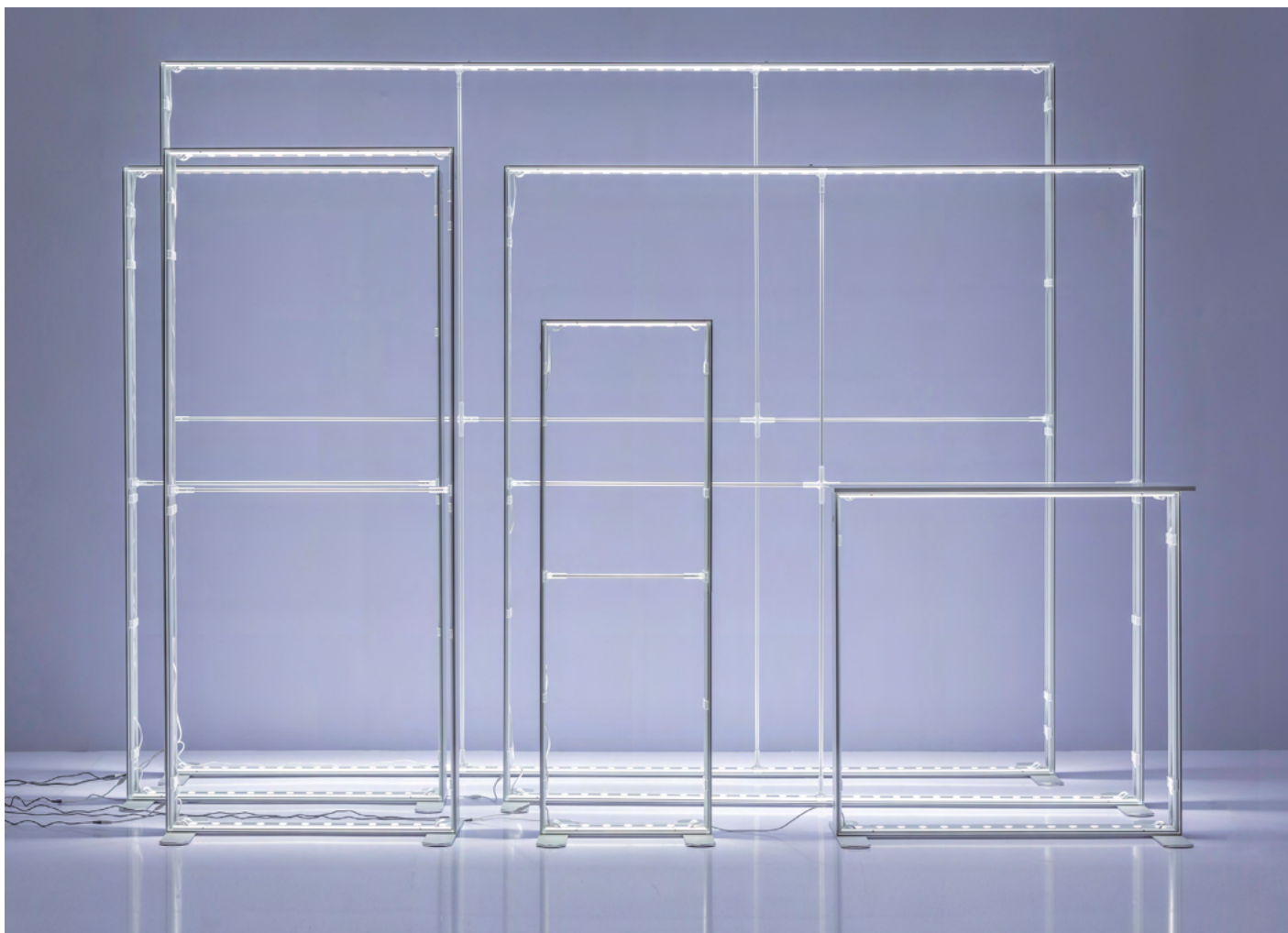

Product Catalog

Graphic • SEGO Basic Lightboxes • SEGO Modular Tradeshow Booths

Accessories • Spare Parts



SEGO: Bright, Quick, Modular

Illuminate your displays with SEGO's powerful **LEDs**, delivering even, stunning backlit graphics. With **a tool-free assembly system** and compact, wheeled bags for transport, SEGO ensures **quick setups** and maximum mobility. Its **modular design** allows endless customization, adapting to any event or space for a truly impactful presentation.

01

Simply click the vertical onto the SEGO foot by pushing it down onto the shaft.



02

Slide the horizontal into the vertical from the front opening.



03

Now push down the latch.



04

Finished!



Modular

Combine SEGO frames to build corners - connect different heights - just as you need. You can also place shelves and monitors on SEGO frames with the easy-to-use accessory.



SEGO

- + **Durable Frames:** Modular aluminum, built to last.
- + **Compact Fabrics:** Lightweight, easy to transport and replace.
- + **Seamless Printing:** Vibrant, premium backlit graphics.
- + **Tool-Free Assembly:** Quick and independent setup.
- + **Easy Customization:** Multiple sizes and configurations available.
- + **Complete Package:** Frames, accessories, and cases included.

Other brands

- **Low Durability:** Substandard materials lead to quicker wear and less reliability.
- **Bulky Materials:** Heavy parts make transport and setup time-consuming.
- **Average Printing:** Colors and graphics lack sharpness, reducing visual impact.
- **Complex Assembly:** Requires tools and extra labor, increasing costs.
- **Limited Options:** Few sizes and configurations restrict customization.
- **Few Accessories:** Limited add-ons reduce personalization and flexibility.

Contents

1. SEGO Modular Lightboxes Basic

2. SEGO Modular Tradeshow Booths 10X10

3. SEGO Modular Tradeshow Booths 10X20

4. SEGO Modular Tradeshow Booths 20X20



5. SEGO Graphic

6. SEGO Accessories

7. SEGO Spare Parts

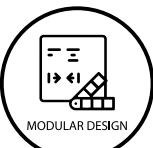
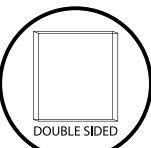
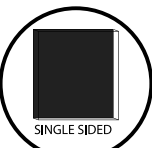

01 SEGO Modular Lightboxes Basic

-  **SEG**
GRAPHICS ARE INSTALLED WITH SILICONE EDGE INSERTED INTO FRAME.
-  TOP QUALITY
-  MODULAR DESIGN
-  DOUBLE SIDED
-  SINGLE SIDED

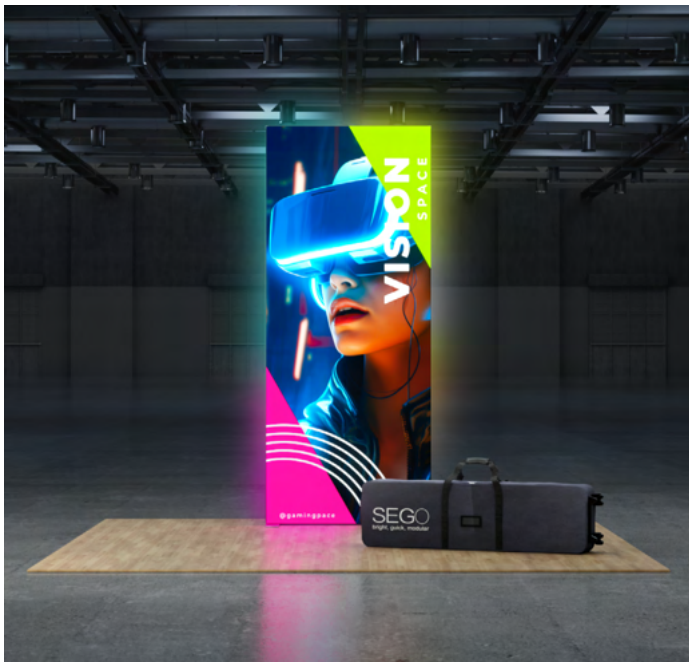

SEGO 8' H Modular Lightbox 3.3×8' (100×240 cm)

Material	SEGO Backlit Graphic (Single or Double-sided, depends on the set)
Finishing	Silicone beading sewn onto edge of graphic
Construction	Aluminum frame with plastic components
Includes	Horizontal and vertical profiles, mid pole, feet, transformer, cables, transportation bag
Lighting	OSRAM LED



SEGO 8' H Modular Lightbox 6.5×8' (200×240 cm)

Material	SEGO Backlit Graphic (Single or Double-sided, depends on the set)
Finishing	Silicone beading sewn onto edge of graphic
Construction	Aluminum frame with plastic components
Includes	Horizontal and vertical profiles, mid pole, feet, transformer, cables, transportation bag
Lighting	OSRAM LED



SEGO 8' H Modular Lightbox 10×8' (300×240 cm)

Material	SEGO Backlit Graphic (Single or Double-sided, depends on the set)
Finishing	Silicone beading sewn onto edge of graphic
Construction	Aluminum frame with plastic components
Includes	Horizontal and vertical profiles, mid pole, feet, transformer, cables, transportation bag
Lighting	OSRAM LED

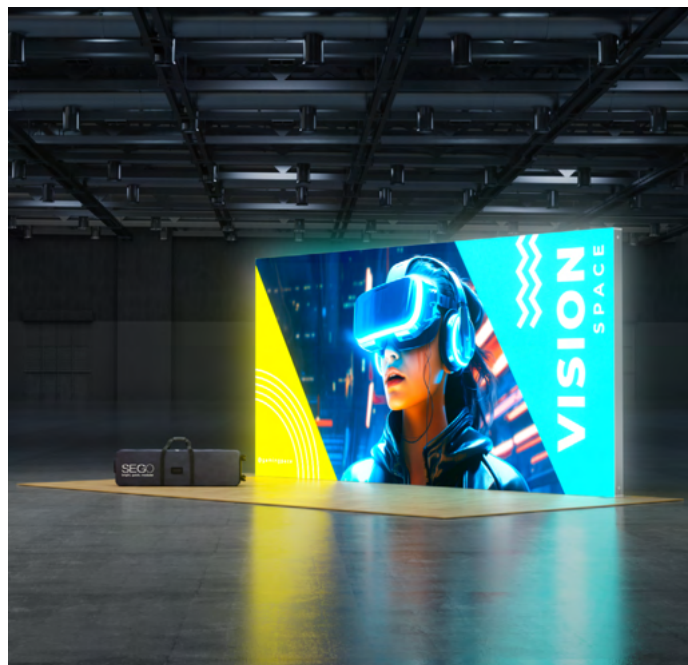

SEGO 8' H Modular Lightbox 16.5×8' (500×240 cm)

Material	SEGO Backlit Graphic (Single or Double-sided, depends on the set)
Finishing	Silicone beading sewn onto edge of graphic
Construction	Aluminum frame with plastic components
Includes	Horizontal and vertical profiles, mid pole, feet, transformer, cables, transportation bag
Lighting	OSRAM LED



SEGO 8' H Modular Lightbox 20×8' (600×240 cm)

Material	SEGO Backlit Graphic (Single or Double-sided, depends on the set)
Finishing	Silicone beading sewn onto edge of graphic
Construction	Aluminum frame with plastic components
Includes	Horizontal and vertical profiles, mid pole, feet, transformer, cables, transportation bag
Lighting	OSRAM LED



SEGO Battery Counter Lightbox 3.3×3.3' (100×100 cm)

Battery	24V Li-ion (50Ah, 1110Wh)
Operation	Up to 24 hours on a single charge
Charging Time	Fully recharges in 10 hours
Construction	Aluminum frame with plastic components
Includes	Countertop, profiles, transformer, battery, cables, transportation bag
Lighting	OSRAM LED



SEGO Counter Lightbox 3.3×3.3' (100×100 cm)

Power Source	Standard plug-in functionality
Construction	Aluminum frame with plastic components
Includes	Countertop, profiles, transformer, cables, transportation bag
Lighting	OSRAM LED





SEGO Bridge/Arch

Material	SEGO Backlit Graphic (Single or Double-sided, depends on the set)
Finishing	Silicone beading sewn onto edge of graphic
Construction	Aluminum frame with plastic components
Includes	Horizontal and vertical profiles, mid pole, feet, transformer, cables, transportation bag, bridge connector (4), bridge middle support (2)
Lighting	OSRAM LED

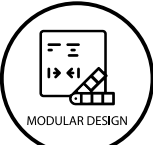
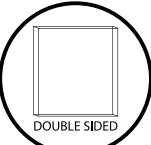
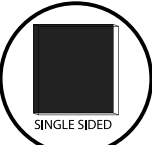

02 SEGO Modular Tradeshow Booths 10X10

-  **SEG**
GRAPHICS ARE INSTALLED
WITH SILICONE EDGE
INSERTED INTO FRAME.
-  **TOP QUALITY**
-  **MODULAR DESIGN**
-  **DOUBLE SIDED**
-  **SINGLE SIDED**



SEGO 8' H SET 1010-01 Modular Booth Double-sided

Included Components:

SEGO 8' H Modular Lightbox 3.3×8' (100×240 cm) – 1 pc
SEGO 8' H Modular Lightbox 6.5×8' (200×240 cm) – 1 pc
Straight Connector – 2 pcs

Graphics:

SEGO Backlit Graphic 3.3×8' (100×240 cm) – 2 pcs
SEGO Backlit Graphic 6.5×8' (200×240 cm) – 2 pcs

Optional Items Not Included:

SEGO Counter Lightbox
Battery Counter Lightbox
SEGO Counter Backlit Graphics
Monitor Bracket Kit
Shelf Kit, Hanging Pole for Shelf Kit



Material

SEGO Backlit Graphic (Single or Double-sided, depends on the set)

Finishing

Silicone beading sewn onto edge of graphic

Construction

Aluminum frame with plastic components

Lighting

OSRAM LED



SEGO 8' H SET 1010-03A Modular Booth Double-sided

Included Components:

SEGO 8' H Modular Lightbox 3.3×8' (100×240 cm) – 3 pcs
SEGO 8' H Modular Lightbox 6.5×8' (200×240 cm) – 1 pc
Straight Connector – 2 pcs
Bridge Connector – 4 pcs
Bridge Middle Support – 2 pcs
Extension Cable 5 m – 1 pc

Graphics:

SEGO Backlit Graphic 3.3×8' (100×240 cm) – 6 pcs
SEGO Backlit Graphic 6.5×8' (200×240 cm) – 2 pcs

Optional Items Not Included:

SEGO Counter Lightbox
Battery Counter Lightbox
SEGO Counter Backlit Graphics
Monitor Bracket Kit
Shelf Kit, Hanging Pole for Shelf Kit



Material

SEGO Backlit Graphic (Single or Double-sided, depends on the set)

Finishing

Silicone beading sewn onto edge of graphic

Construction

Aluminum frame with plastic components

Lighting

OSRAM LED



SEGO 8' H SET 1010-03B Modular Booth Double-sided

Included Components:

SEGO 8' H Modular Lightbox 3.3×8' (100×240 cm) – 2 pcs
 SEGO 8' H Modular Lightbox 10×8' (300×240 cm) – 1 pc
 Bridge Connector – 3 pcs
 Bridge Connector for 283M – 1 pc
 Bridge Middle Support – 2 pcs
 Extension Cable 5 m – 1 pc

Graphics:

SEGO Backlit Graphic 3.3×8' (100×240 cm) – 4 pcs
 SEGO Backlit Graphic 10×8' (300×240 cm) – 2 pcs

Optional Items Not Included:

SEGO Counter Lightbox
Battery Counter Lightbox
 SEGO Counter Backlit Graphics
 Monitor Bracket Kit
 Shelf Kit. Hanging Pole for Shelf Kit

Material

SEGO Backlit Graphic (Single or Double-sided, depends on the set)

Finishing

Silicone beading sewn onto edge of graphic

Construction

Aluminum frame with plastic components

Lighting

OSRAM LED

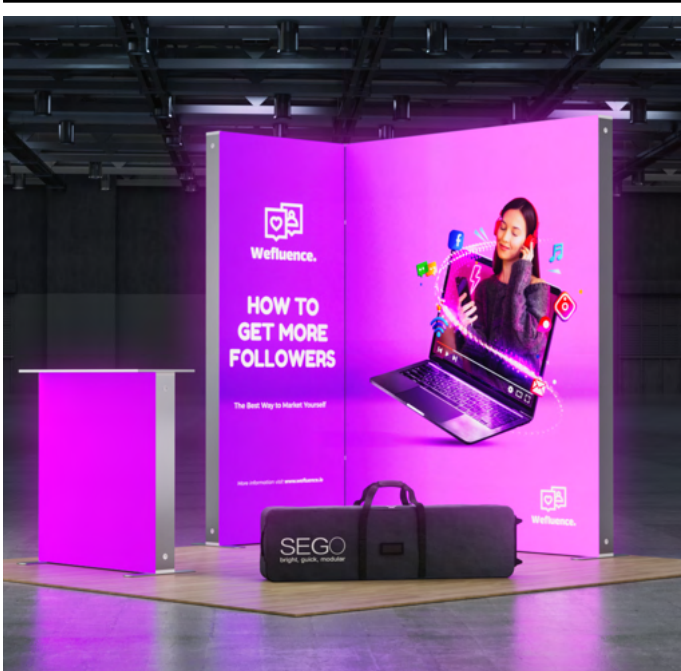

SEGO 8' H SET 1010-05 Modular Booth Double-sided

Included Components:

SEGO 8' H Modular Lightbox 3.3×8' (100×240 cm) – 1 pc
 SEGO 8' H Modular Lightbox 6.5×8' (200×240 cm) – 1 pc
 L Connector Outside – 2 pcs
 Mini Foot – 1 pc

Graphics:

SEGO Backlit Graphic 3.3×8' (100×240 cm) – 2 pcs
 SEGO Backlit Graphic 6.5×8' (200×240 cm) – 2 pcs

Optional Items Not Included:

SEGO Counter Lightbox
Battery Counter Lightbox
 SEGO Counter Backlit Graphics
 Monitor Bracket Kit
 Shelf Kit. Hanging Pole for Shelf Kit

Material

SEGO Backlit Graphic (Single or Double-sided, depends on the set)

Finishing

Silicone beading sewn onto edge of graphic

Construction

Aluminum frame with plastic components

Lighting

OSRAM LED

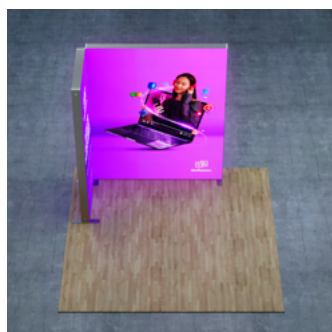
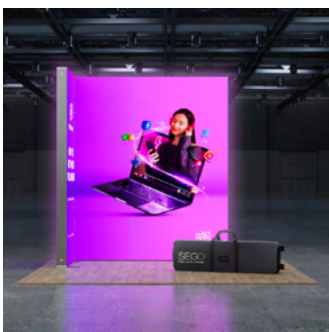



SEGO 8' H SET 1010-06 Modular Booth Double-sided

Included Components:

SEGO 8' H Modular Lightbox 6.5x8' (200x240 cm) – 1 pc
 SEGO Counter Lightbox 3.3x3.3' (100x100 cm) – 1 pc
 High-low Connector – 1 pc

Graphics:

SEGO Backlit Graphic 6.5x8' (200x240 cm) – 2 pcs
 SEGO Backlit Graphic 3.3x3.3' (100x100 cm) – 2 pcs

Optional Items Not Included:

SEGO Counter Lightbox
Battery Counter Lightbox
 SEGO Counter Backlit Graphics

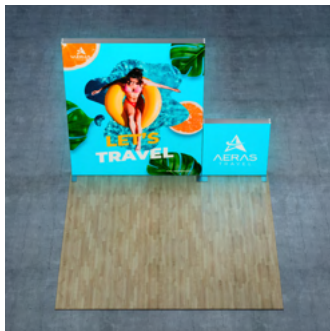
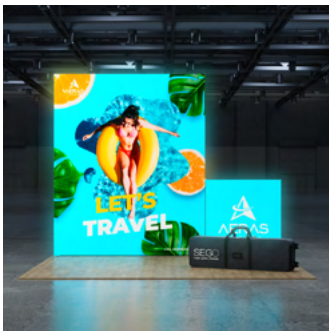

Material

SEGO Backlit Graphic (Single or Double-sided, depends on the set)

Finishing

Silicone beading sewn onto edge of graphic

Construction

Aluminum frame with plastic components

Lighting

OSRAM LED



SEGO 8' H SET 1010-07A Modular Booth Double-sided

Included Components:

SEGO 8' H Modular Lightbox 10x8' (300x240 cm) – 1 pc
 SEGO Counter Lightbox 3.3x3.3' (100x100 cm) – 2 pcs
 L Connector Inside – 4 pcs

Graphics:

SEGO Backlit Graphic 10x8' (300x240 cm) – 2 pcs
 SEGO Backlit Graphic 3.3x3.3' (100x100 cm) – 4 pcs

Optional Items Not Included:

SEGO Counter Lightbox
Battery Counter Lightbox
 SEGO Counter Backlit Graphics
 Monitor Bracket Kit
 Shelf Kit, Hanging Pole for Shelf Kit

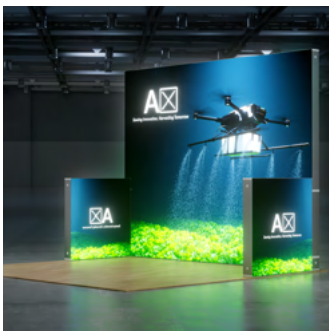

Material

SEGO Backlit Graphic (Single or Double-sided, depends on the set)

Finishing

Silicone beading sewn onto edge of graphic

Construction

Aluminum frame with plastic components

Lighting

OSRAM LED



SEGO 8' H SET 1010-07B Modular Booth Double-sided

Included Components:

SEGO 8' H Modular Lightbox 6.5×8' (200×240 cm) – 1 pc
 SEGO 8' H Modular Lightbox 3.3×8' (100×240 cm) – 1 pc
 SEGO Counter Lightbox 3.3×3.3' (100×100 cm) – 2 pcs
 Straight Connector – 2 pcs
 L Connector Inside – 4 pcs

Graphics:

SEGO Backlit Graphic 6.5×8' (200×240 cm) – 2 pcs
 SEGO Backlit Graphic 3.3×8' (100×240 cm) – 2 pcs
 SEGO Backlit Graphic 3.3×3.3' (100×100 cm) – 4 pcs

Optional Items Not Included:

SEGO Counter Lightbox
Battery Counter Lightbox
 SEGO Counter Backlit Graphics



Material

SEGO Backlit Graphic (Single or Double-sided, depends on the set)

Finishing

Silicone beading sewn onto edge of graphic

Construction

Aluminum frame with plastic components

Lighting

OSRAM LED



SEGO 8' H SET 1010-08 Modular Booth Double-sided

Included Components:

SEGO 8' H Modular Lightbox 10×8' (300×240 cm) – 2 pcs
 L Connector Outside – 2 pcs
 Foot Half Right – 1 pc

Graphics:

SEGO Backlit Graphic 10×8' (300×240 cm) – 4 pcs

Optional Items Not Included:

SEGO Counter Lightbox
Battery Counter Lightbox
 SEGO Counter Backlit Graphics
 Monitor Bracket Kit
 Shelf Kit, Hanging Pole for Shelf Kit

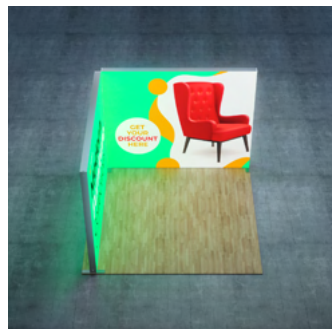
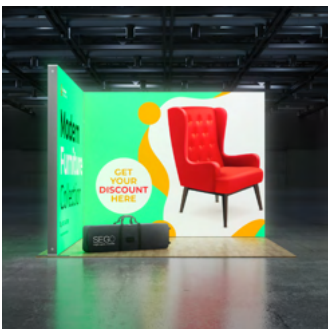

Material

SEGO Backlit Graphic (Single or Double-sided, depends on the set)

Finishing

Silicone beading sewn onto edge of graphic

Construction

Aluminum frame with plastic components

Lighting

OSRAM LED



SEGO 8' H SET 1010-09A Modular Booth Double-sided

Included Components:

SEGO 8' H Modular Lightbox 3.3×8' (100×240 cm) – 3 pcs
 SEGO 8' H Modular Lightbox 10×8' (300×240 cm) – 1 pc
 Door Kit – 1 pc
 L Connector Inside – 2 pcs
 Mini Foot – 1 pc

Graphics:

SEGO Backlit Graphic 3.3×8' (100×240 cm) – 6 pcs
 SEGO Backlit Graphic 10×8' (300×240 cm) – 2 pcs

Optional Items Not Included:

SEGO Counter Lightbox
Battery Counter Lightbox
 SEGO Counter Backlit Graphics
 Monitor Bracket Kit
 Shelf Kit, Hanging Pole for Shelf Kit

Material

SEGO Backlit Graphic (Single or Double-sided, depends on the set)

Finishing

Silicone beading sewn onto edge of graphic

Construction

Aluminum frame with plastic components

Lighting

OSRAM LED

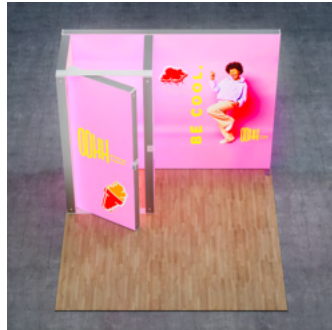

SEGO 8' H SET 1010-12 Modular Booth Double-sided

Included Components:

SEGO 8' H Modular Lightbox 3.3×8' (100×240 cm) – 3 pcs
 SEGO 8' H Modular Lightbox 6.5×8' (200×240 cm) – 2 pcs
 Door Kit – 1 pc
 Straight Connector – 2 pcs
 L Connector Inside – 4 pcs
 Mini Foot – 2 pcs

Graphics:

SEGO Backlit Graphic 3.3×8' (100×240 cm) – 6 pcs
 SEGO Backlit Graphic 6.5×8' (200×240 cm) – 4 pcs

Optional Items Not Included:

SEGO Counter Lightbox
Battery Counter Lightbox
 SEGO Counter Backlit Graphics
 Monitor Bracket Kit
 Shelf Kit, Hanging Pole for Shelf Kit

Material

SEGO Backlit Graphic (Single or Double-sided, depends on the set)

Finishing

Silicone beading sewn onto edge of graphic

Construction

Aluminum frame with plastic components

Lighting

OSRAM LED





SEGO 8' H SET 1010-13 Modular Booth Double-sided

Included Components:

SEGO 8' H Modular Lightbox 3.3×8' (100×240 cm) – 2 pcs
 SEGO 8' H Modular Lightbox 10×8' (300×240 cm) – 2 pcs
 Door Kit – 1 pc
 L Connector Inside – 4 pcs
 Mini Foot – 2 pcs

Graphics:

SEGO Backlit Graphic 3.3×8' (100×240 cm) – 4 pcs
 SEGO Backlit Graphic 10×8' (300×240 cm) – 4 pcs

Optional Items Not Included:

SEGO Counter Lightbox
Battery Counter Lightbox
 SEGO Counter Backlit Graphics
 Monitor Bracket Kit
 Shelf Kit, Hanging Pole for Shelf Kit

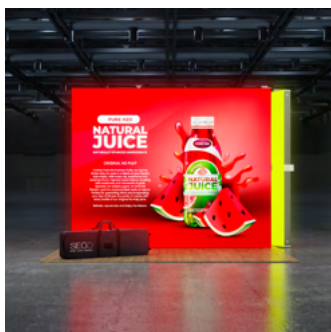

Material

SEGO Backlit Graphic (Single or Double-sided, depends on the set)

Finishing

Silicone beading sewn onto edge of graphic

Construction

Aluminum frame with plastic components

Lighting

OSRAM LED



03 SEGO Modular Tradeshow Booths 10X20

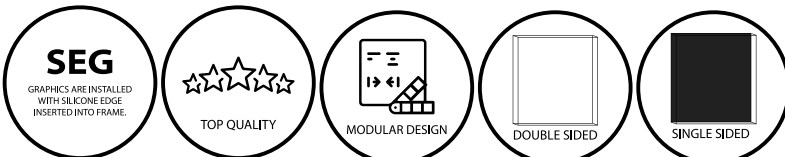



SEGO 8' H SET 1020-01 Modular Booth Double-sided

Included Components:

SEGO 8' H Modular Lightbox 10×8' (300×240 cm) – 2 pcs
Straight Connector – 2 pcs

Graphics:

SEGO Backlit Graphic 10×8' (300×240 cm) – 4 pcs

Optional Items Not Included:

SEGO Counter Lightbox
Battery Counter Lightbox
SEGO Counter Backlit Graphics

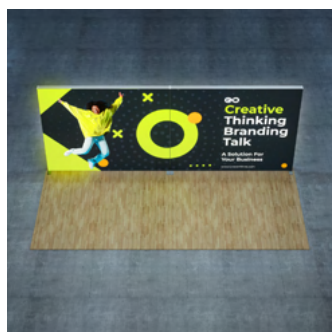
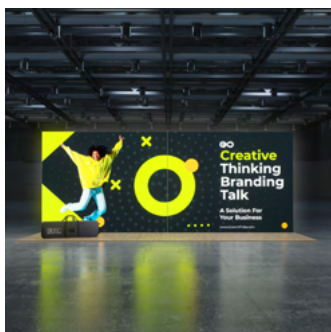

Material

SEGO Backlit Graphic (Single or Double-sided, depends on the set)

Finishing

Silicone beading sewn onto edge of graphic

Construction

Aluminum frame with plastic components

Lighting

OSRAM LED



SEGO 8' H SET 1020-02 Modular Booth Double-sided

Included Components:

SEGO 8' H Modular Lightbox 3.3×8' (100×240 cm) – 4 pcs
SEGO 8' H Modular Lightbox 10×8' (300×240 cm) – 2 pcs
Straight Connector – 2 pcs
Bridge Connector – 6 pcs
Bridge Connector for 2&3M – 2 pcs
Bridge Middle Support – 4 pcs
Extension Cable 5m – 4 pcs

Graphics:

SEGO Backlit Graphic 3.3×8' (100×240 cm) – 8 pcs
SEGO Backlit Graphic 10×8' (300×240 cm) – 4 pcs

Optional Items Not Included:

SEGO Counter Lightbox
Battery Counter Lightbox
SEGO Counter Backlit Graphics
Monitor Bracket Kit 100 cm
Shelf Kit 100 cm, Hanging Pole for Shelf Kit



Material

SEGO Backlit Graphic (Single or Double-sided, depends on the set)

Finishing

Silicone beading sewn onto edge of graphic

Construction

Aluminum frame with plastic components

Lighting

OSRAM LED



SEGO 8' H SET 1020-03 Modular Booth Double-sided

Included Components:

SEGO 8' H Modular Lightbox 6.5×8' (200×240 cm) – 1 pc
 SEGO 8' H Modular Lightbox 10×8' (300×240 cm) – 2 pcs
 Straight Connector – 2 pcs
 L Connector Outside – 2 pcs
 Foot Half Right – 1 pc

Graphics:

SEGO Backlit Graphic 6.5×8' (200×240 cm) – 2 pcs
 SEGO Backlit Graphic 10×8' (300×240 cm) – 4 pcs

Optional Items Not Included:

SEGO Counter Lightbox
Battery Counter Lightbox
 SEGO Counter Backlit Graphics



Material

SEGO Backlit Graphic (Single or Double-sided, depends on the set)

Finishing

Silicone beading sewn onto edge of graphic

Construction

Aluminum frame with plastic components

Lighting

OSRAM LED



SEGO 8' H SET 1020-04B Modular Booth Double-sided

Included Components:

SEGO 8' H Modular Lightbox 3.3×8' (100×240 cm) – 3 pcs
 SEGO 8' H Modular Lightbox 10×8' (300×240 cm) – 2 pcs
 Straight Connector – 2 pcs
 Door Kit – 1 pc
 L Connector Inside – 2 pcs
 Mini Foot – 1 pc

Graphics:

SEGO Backlit Graphic 3.3×8' (100×240 cm) – 6 pcs
 SEGO Backlit Graphic 10×8' (300×240 cm) – 4 pcs

Optional Items Not Included:

SEGO Counter Lightbox
Battery Counter Lightbox
 SEGO Counter Backlit Graphics
 Monitor Bracket Kit 100 cm
 Shelf Kit 100 cm, Hanging Pole for Shelf Kit



Material

SEGO Backlit Graphic (Single or Double-sided, depends on the set)

Finishing

Silicone beading sewn onto edge of graphic

Construction

Aluminum frame with plastic components

Lighting

OSRAM LED



SEGO 8' H SET 1020-05 Modular Booth Double-sided

Included Components:

SEGO 8' H Modular Lightbox 3.3×8' (100×240 cm) – 7 pcs
 SEGO 8' H Modular Lightbox 6.5×8' (200×240 cm) – 1 pc
 SEGO 8' H Modular Lightbox 10×8' (300×240 cm) – 1 pc
 Straight Connector – 6 pcs
 L Connector Inside – 4 pcs
 Bridge Connector – 3 pcs
 Bridge Connector for 283M – 1 pc
 Bridge Middle Support – 2 pcs
 Door Kit – 1 pc
 Extension Cable 5m – 4 pcs
 Mini Foot – 2 pcs

Graphics:

SEGO Backlit Graphic 3.3×8' (100×240 cm) – 14 pcs
 SEGO Backlit Graphic 6.5×8' (200×240 cm) – 2 pcs
 SEGO Backlit Graphic 10×8' (300×240 cm) – 2 pcs

Optional Items Not Included:

SEGO Counter Lightbox, **Battery Counter** Lightbox, SEGO Counter Backlit Graphics, Monitor Bracket Kit 100 cm, Shelf Kit 100 cm, Hanging Pole for Shelf Kit

Material

SEGO Backlit Graphic (Single or Double-sided, depends on the set)

Finishing

Silicone beading sewn onto edge of graphic

Construction

Aluminum frame with plastic components

Lighting

OSRAM LED



SEGO 8' H SET 1020-07 Modular Booth Double-sided

Included Components:

SEGO 8' H Modular Lightbox 3.3×8' (100×240 cm) – 2 pcs
 SEGO 8' H Modular Lightbox 10×8' (300×240 cm) – 3 pcs
 L Connector Inside – 4 pcs
 Door Kit – 1 pc
 Mini Foot – 2 pcs

Graphics:

SEGO Backlit Graphic 3.3×8' (100×240 cm) – 4 pcs
 SEGO Backlit Graphic 10×8' (300×240 cm) – 6 pcs

Optional Items Not Included:

SEGO Counter Lightbox
Battery Counter Lightbox
 SEGO Counter Backlit Graphics
 Monitor Bracket Kit 100 cm
 Shelf Kit 100 cm, Hanging Pole for Shelf Kit

Material

SEGO Backlit Graphic (Single or Double-sided, depends on the set)

Finishing

Silicone beading sewn onto edge of graphic

Construction

Aluminum frame with plastic components

Lighting

OSRAM LED

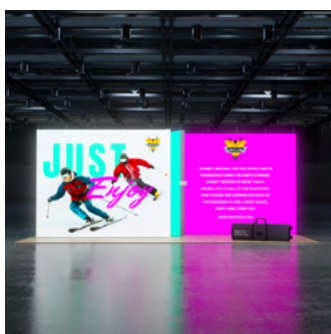



SEGO 8' H SET 1020-08 Modular Booth Double-sided

Included Components:

SEGO 8' H Modular Lightbox 3.3×8' (100×240 cm) – 4 pcs
SEGO 8' H Modular Lightbox 6.5×8' (200×240 cm) – 1 pc
Straight Connector – 8 pcs

Graphics:

SEGO Backlit Graphic 3.3×8' (100×240 cm) – 8 pcs
SEGO Backlit Graphic 6.5×8' (200×240 cm) – 2 pcs

Optional Items Not Included:

SEGO Counter Lightbox
Battery Counter Lightbox
SEGO Counter Backlit Graphics
Monitor Bracket Kit 100 cm
Shelf Kit 100 cm, Hanging Pole for Shelf Kit

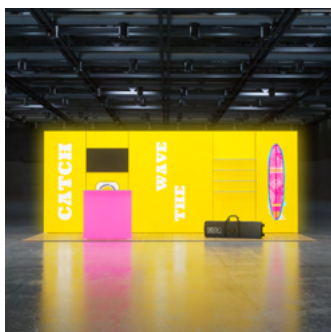

Material

SEGO Backlit Graphic (Single or Double-sided, depends on the set)

Finishing

Silicone beading sewn onto edge of graphic

Construction

Aluminum frame with plastic components

Lighting

OSRAM LED



SEGO 8' H SET 1020-08B Modular Booth Double-sided

Included Components:

SEGO 8' H Modular Lightbox 3.3×8' (100×240 cm) – 4 pcs
SEGO 8' H Modular Lightbox 6.5×8' (200×240 cm) – 1 pc
Extension cable – 1 pc
Straight Connector – 4 pcs
H Connector – 2 pcs
High-Low Connector – 2 pcs

Graphics:

SEGO Backlit Graphic 3.3×8' (100×240 cm) – 8 pcs
SEGO Backlit Graphic 6.5×8' (200×240 cm) – 2 pcs

Optional Items Not Included:

SEGO Counter Lightbox
Battery Counter Lightbox
SEGO Counter Backlit Graphics
Monitor Bracket Kit 100 cm
Shelf Kit 100 cm, Hanging Pole for Shelf Kit



Material

SEGO Backlit Graphic (Single or Double-sided, depends on the set)

Finishing

Silicone beading sewn onto edge of graphic

Construction

Aluminum frame with plastic components

Lighting

OSRAM LED



SEGO 8' H SET 1020-09 Modular Booth Double-sided

Included Components:

SEGO 8' H Modular Lightbox 3.3×8' (100×240 cm) – 6 pcs
 SEGO 8' H Modular Lightbox 10×8' (300×240 cm) – 2 pcs
 Door Kit – 1 pc
 Straight Connector – 8 pcs
 L Connector Inside – 4 pcs
 Mini Foot – 2 pcs

Graphics:

SEGO Backlit Graphic 3.3×8' (100×240 cm) – 12 pcs
 SEGO Backlit Graphic 10×8' (300×240 cm) – 4 pcs

Optional Items Not Included:

SEGO Counter Lightbox
Battery Counter Lightbox
 SEGO Counter Backlit Graphics
 Monitor Bracket Kit 100 cm
 Shelf Kit 100 cm, Hanging Pole for Shelf Kit



Material

SEGO Backlit Graphic (Single or Double-sided, depends on the set)

Finishing

Silicone beading sewn onto edge of graphic

Construction

Aluminum frame with plastic components

Lighting

OSRAM LED



SEGO 8' H SET 1020-13 Modular Booth Double-sided

Included Components:

SEGO 8' H Modular Lightbox 3.3×8' (100×240 cm) – 6 pcs
 SEGO 8' H Modular Lightbox 6.5×8' (200×240 cm) – 1 pc
 Extension cable – 2 pcs
 Straight Connector – 2 pcs
 L Connector Inside – 2 pcs
 H Connector – 4 pcs
 High-Low Connector – 4 pcs
 Foot Half Left – 1 pc
 Foot Half Right – 1 pc

Graphics:

SEGO Backlit Graphic 3.3×8' (100×240 cm) – 12 pcs
 SEGO Backlit Graphic 6.5×8' (200×240 cm) – 2 pcs

Optional Items Not Included:

SEGO Counter Lightbox
Battery Counter Lightbox
 SEGO Counter Backlit Graphics
 Monitor Bracket Kit 100 cm
 Shelf Kit 100 cm, Hanging Pole for Shelf Kit

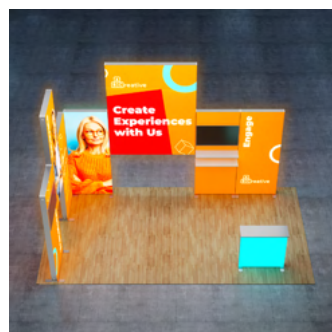
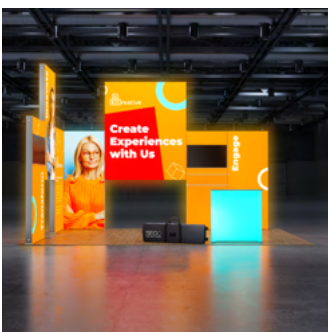

Material

SEGO Backlit Graphic (Single or Double-sided, depends on the set)

Finishing

Silicone beading sewn onto edge of graphic

Construction

Aluminum frame with plastic components

Lighting

OSRAM LED



04 SEGO Modular Tradeshow Booths 20X20

- 

SEG
GRAPHICS ARE INSTALLED
WITH SILICONE EDGE
INSERTED INTO FRAME.
- 

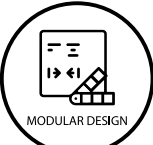
TOP QUALITY
- 

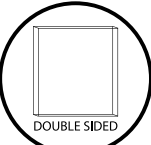
MODULAR DESIGN
- 

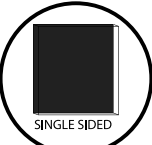
DOUBLE SIDED
- 

SINGLE SIDED



SEGO 8' H SET 2020-01 Modular Booth Double-sided

Included Components:

SEGO 8' H Modular Lightbox 3.3×8' (100×240 cm) – 6 pcs
 SEGO 8' H Modular Lightbox 6.5×8' (200×240 cm) – 3 pcs
 Extension cable – 3 pcs
 L-Connector Outside – 4 pcs
 High-low Connector – 6 pcs
 H Connector – 6 pcs
 Foot Half Left – 2 pcs
 Foot Half Right – 2 pcs

Graphics:

SEGO Backlit Graphic 3.3×8' (100×240 cm) – 12 pcs
 SEGO Backlit Graphic 6.5×8' (200×240 cm) – 6 pcs

Optional Items Not Included:

SEGO Counter Lightbox
 SEGO **Battery Counter** Lightbox
 SEGO Counter Backlit Graphic
 Monitor Bracket Kit
 Shelf Kit, Hanging Pole for Shelf Kit

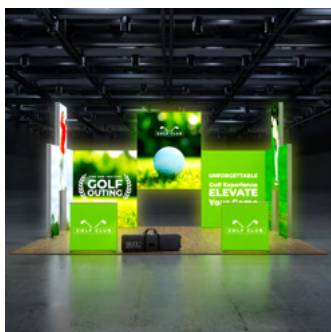

Material

SEGO Backlit Graphic (Single or Double-sided, depends on the set)

Finishing

Silicone beading sewn onto edge of graphic

Construction

Aluminum frame with plastic components

Lighting

OSRAM LED



SEGO 8' H SET 2020-04 Modular Booth Double-sided

Included Components:

SEGO 8' H Modular Lightbox 3.3×8' (100×240 cm) – 8 pcs
 SEGO Counter Lightbox 3.3×3.3' (100×100 cm) – 4 pcs
 L-Connector (Inside) – 16 pcs
 Stacking Connector – 8 pcs
 Extension Cable 5m – 4 pcs
 Foot Half Left – 4 pcs
 Foot Half Right – 4 pcs

Graphics:

SEGO Backlit Graphic 3.3×8' (100×240 cm) – 16 pcs
 SEGO Backlit Graphic 3.3×3.3' (100×100 cm) – 8 pcs

Optional Items Not Included:

SEGO Counter Lightbox
 SEGO **Battery Counter** Lightbox
 SEGO Counter Backlit Graphic
 Door Kit
 Monitor Bracket Kit
 Shelf Kit, Hanging Pole for Shelf Kit

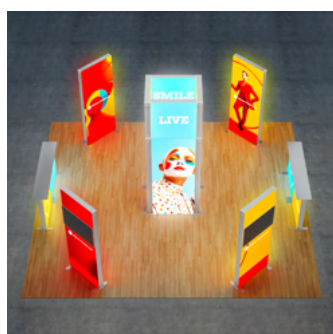

Material

SEGO Backlit Graphic (Single or Double-sided, depends on the set)

Finishing

Silicone beading sewn onto edge of graphic

Construction

Aluminum frame with plastic components

Lighting

OSRAM LED

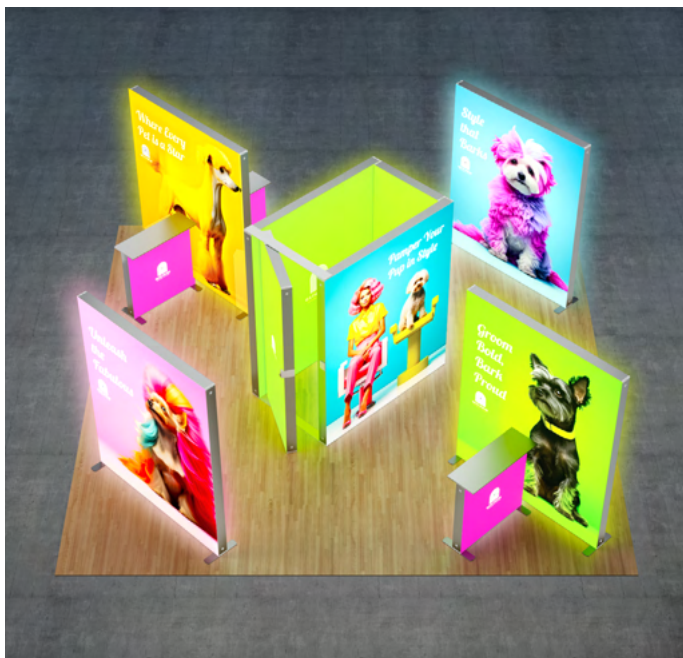

SEGO 8' H SET 2020-05 Modular Booth Double-sided

Included Components:

SEGO 8' H Modular Lightbox 3.3×8' (100×240 cm) – 2 pcs
 SEGO 8' H Modular Lightbox 6.5×8' (200×240 cm) – 6 pcs
 L-Connector (Inside) – 4 pcs
 Door Kit – 1 pcs
 Mini Foot – 2 pcs

Graphics:

SEGO Backlit Graphic 3.3×8' (100×240 cm) – 4 pcs
 SEGO Backlit Graphic 6.5×8' (200×240 cm) – 12 pcs

Optional Items Not Included:

SEGO Counter Lightbox
 SEGO **Battery Counter** Lightbox
 SEGO Counter Backlit Graphic
 Monitor Bracket Kit
 Shelf Kit, Hanging Pole for Shelf Kit
 SEGO Counter Backlit Graphics



Material

SEGO Backlit Graphic (Single or Double-sided, depends on the set)

Finishing

Silicone beading sewn onto edge of graphic

Construction

Aluminum frame with plastic components

Lighting

OSRAM LED



SEGO 8' H SET 2020-06 Modular Booth Double-sided

Included Components:

SEGO 8' H Modular Lightbox 3.3×8' (100×240 cm) – 11 pcs
 SEGO 8' H Modular Lightbox 6.5×8' (200×240 cm) – 3 pcs
 Straight Connector – 2 pcs
 L-Connector Inside – 6 pcs
 L-Connector Outside – 2 pcs
 High-low Connector – 5 pcs
 Door Kit – 1 pcs
 Stacking Connector – 4 pcs
 H Connector – 4 pcs
 Extension Cable 5m – 4 pcs
 Mini Foot – 3 pcs
 Foot Half Right – 1 pcs, Foot Half Left – 1 pcs

Graphics:

SEGO Backlit Graphic 3.3×8' (100×240 cm) – 22 pcs
 SEGO Backlit Graphic 6.5×8' (200×240 cm) – 6 pcs

Optional Items Not Included:

SEGO Counter Lightbox, SEGO **Battery Counter** Lightbox, SEGO Counter Backlit Graphic, Monitor Bracket Kit, Shelf Kit, Hanging Pole for Shelf Kit

Material

SEGO Backlit Graphic (Single or Double-sided, depends on the set)

Finishing

Silicone beading sewn onto edge of graphic

Construction

Aluminum frame with plastic components

Lighting

OSRAM LED

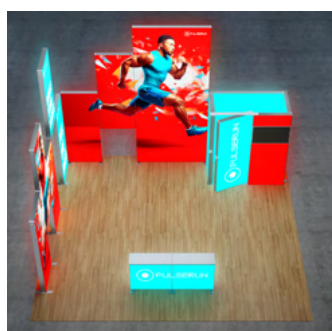
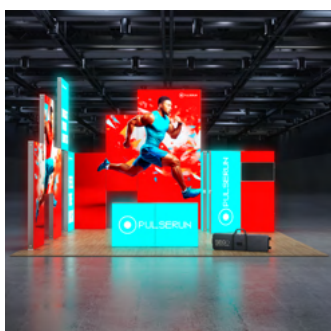



05 SEGO Graphic

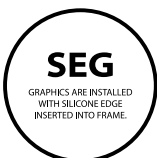



SEGO Backlit Graphic

Size options	3.3×3.3 ft (100x100 cm)
	3.3×8 ft (100x240 cm)
	6.5×8 ft (200x240 cm)
	10×8 ft (300x240 cm)
	16.5×8 ft (500x240 cm)
	20×8 ft (600x240 cm)

Silicone keder	10x3 mm
-----------------------	---------



SEGO Blackback Backing (black outside)

Size options	3.3×3.3 ft (100x100 cm)
	3.3×8 ft (100x240 cm)
	6.5×8 ft (200x240 cm)
	10×8 ft (300x240 cm)
	16.5×8 ft (500x240 cm)
	20×8 ft (600x240 cm)

Silicone keder	10x3 mm
-----------------------	---------

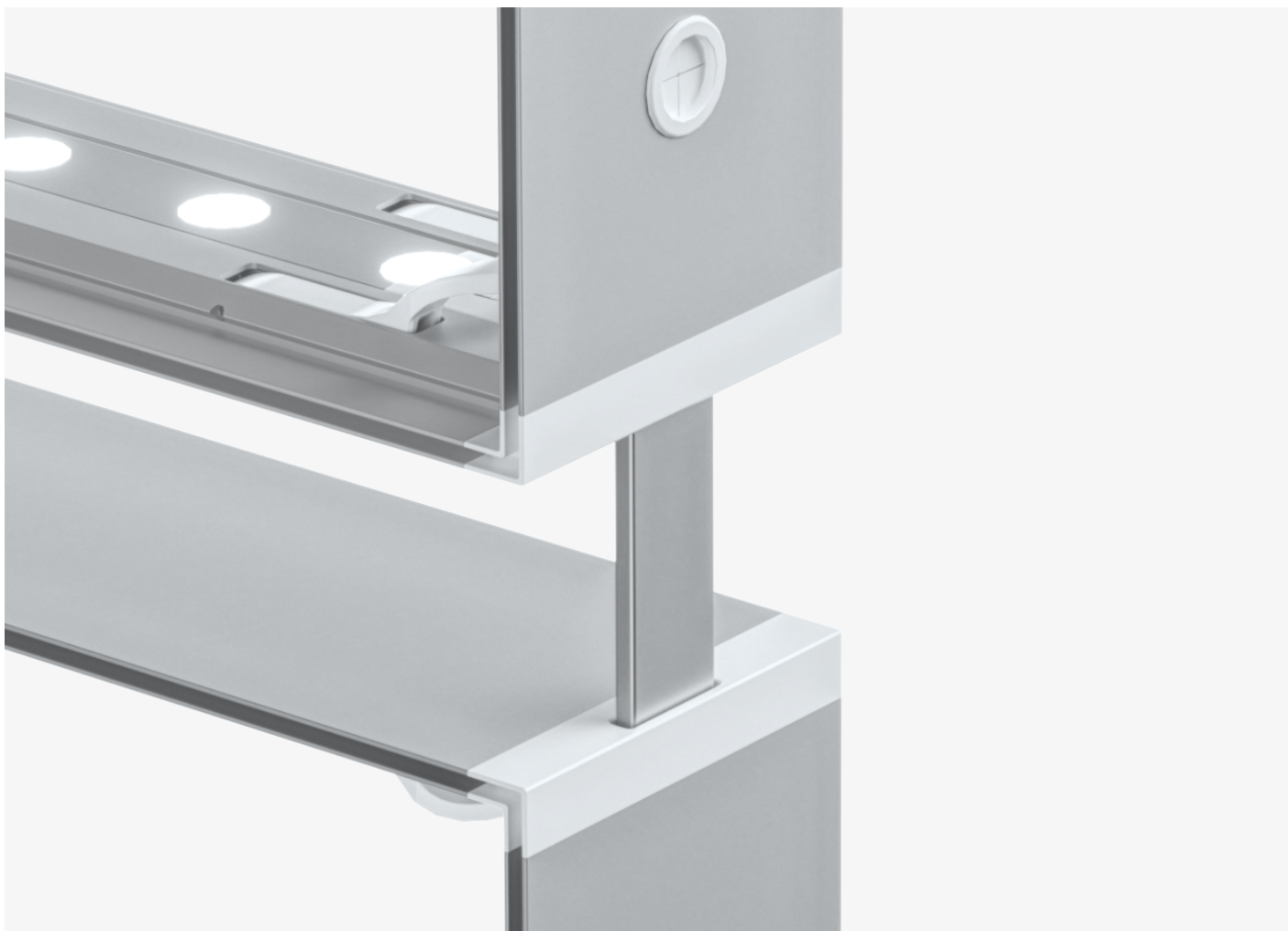

06 SEGO Accessories

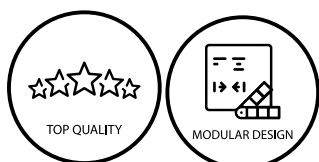



Bridge Connector

Weight 0.150 lbs

Dimensions 1 × 10 × 5 in

Designed to link two SEGO lightboxes, creating a bridge structure between them. This accessory enables the formation of archways or the linking of separate stands, expanding configuration and design possibilities for exhibition setups.

Usage Note: For optimal stability, it is recommended to use the Bridge Connector in conjunction with other SEGO accessories, such as bridge reinforcements, following the manufacturer's instructions.



Bridge Connector for 2&3M

Weight 0.22 lbs

Dimensions 11 × 3.5 × 0.5 in

The Bridge Connector is an essential accessory designed to link two SEGO lightboxes, creating a bridge structure between them. This component is compatible with both 2-meter and 3-meter wide SEGO lightbox panels, allowing for versatile configurations in exhibition and display setups.

Usage Note: For optimal stability, it is recommended to use the Bridge Connector in conjunction with other SEGO accessories, such as bridge reinforcements, following the manufacturer's instructions.



Bridge Middle Support

Weight 0.5 lbs

Dimensions 20 × 4 × 1 in

The Bridge Middle Support is designed to reinforce SEGO modular lightboxes, providing additional rigidity at connection points between frames and horizontal elements.





Door Kit

Weight 17 lbs

Dimensions 57 × 6 × 3 in

The Door Kit is designed to integrate seamlessly with SEGO modular lightboxes, providing convenient access to the internal space of the structure. This accessory is ideal for creating concealed storage areas or technical compartments within exhibition stands.

Compatible with various SEGO lightbox configurations, including 10×10, 20×10, 20×20 ft models and others. Provides organized storage while maintaining the clean, professional appearance of the display.



Straight Connector

Weight 0.08 lbs

Dimensions 3 × 1.5 × 1.5 in

Straight Connector is an accessory designed to join two SEGO modular lightboxes into a single straight structure. It provides a strong and stable connection, enabling the creation of longer and continuous display stands.



Hanging Pole for Shelf Kit

Weight 0.2 lbs

Dimensions 9.5 × 3 × 1 in

The Hanging Pole is designed to be mounted beneath the shelf in SEGO modular lightboxes, allowing items to be displayed on hangers. This accessory enhances the functionality of the setup by providing additional space for showcasing products.





High-Low Connector

Weight 0.035 lbs
Dimensions 5.25 x 2 x 0.5 in

High-Low Connector is a specialized component designed to connect SEGO modular lightboxes at varying height levels. It enables the creation of stepped structures, providing a smooth transition between sections of different heights and giving the display a dynamic and appealing appearance. Ideal for creating **multi-level displays**, exhibition stands, and other structures requiring height variation.



L Connector Outside

Weight 0.075 lbs
Dimensions 5.25 x 5.25 x 1 in

The L Connector Outside is a plastic accessory designed to connect two SEGO modular lightboxes at an external 90-degree angle. It enables the creation of corner structures, expanding configuration and design possibilities for exhibition setups. Allows the creation of various **corner structures**, adapting to specific event or exhibition needs.



H Connector

Weight 0.2 lbs
Dimensions 6.5 x 2 x 0.5 in

The H Connector is designed for installation at the vertical junction of a frame, enabling the adjacent lightbox to be mounted at a higher level. This component allows the lightbox to be elevated by 1.5 times the standard height, offering creative and functional display solutions.

Stability: When paired with High-Low connectors, provides a reliable and secure structural connection.





Stacking Connector

Weight	0.21 lbs
Dimensions	12.1 × 1.5 × 0.5 in

The Stacking Connector is designed to join two vertical frames of SEGO lightboxes, allowing one lightbox to be stacked on top of another. This component is essential for creating tall and multi-level display setups.



Shelf

Weight	8 lbs
Dimensions	42 × 16 × 3 in

The Shelf for SEGO is an accessory designed to integrate seamlessly with SEGO modular lightboxes, expanding their functionality. It is ideal for displaying products, promotional materials, or exhibits while complementing the overall design of the stand. Suitable for items weighing up to 5 kg (11 lbs) per shelf.



Monitor Bracket

Weight	8.7 lbs
Dimensions	41 × 12 × 4 in

Monitor Bracket is an accessory designed to integrate a monitor with SEGO modular lightboxes, enabling the display of dynamic content and enhancing audience engagement at exhibitions and presentations. Suitable for monitors up to 40 inches in size and weighing up to 25 lbs (11.3 kg).



L Connector Inside

Weight	0.055 lbs
Dimensions	5.25 × 5.25 × 1 in

The L Connector Inside is a plastic accessory designed to connect two SEGO modular lightboxes at an internal 90-degree angle. It is used to create corner structures, enhancing the versatility of exhibition stand designs.



Foot Half Left

Weight 1 lbs
Dimensions 10.5 × 3.5 × 6.5 in

The Foot Half Left is designed to provide stability for SEGO modular lightboxes on one side and is also utilized for creating corner connections, offering flexibility for various configurations.



Foot Half Right

Weight 1 lbs
Dimensions 10.5 × 3.5 × 6.5 in

The Foot Half Right is designed to provide stability for SEGO modular lightboxes on one side and is also utilized for creating corner connections, making it a versatile accessory for various configurations.



Mini Foot

Weight 0.06 lbs
Dimensions 5 × 1.5 × 2 in

The Mini Foot is specifically designed for corner connections in SEGO modular lightboxes where standard feet cannot be used. While it does not provide support against tipping or shifting, it ensures that the lightbox remains at the same height as other sections with standard feet.



Extension Cable 5m

Weight 0.7 lbs
Dimensions 7 × 3.5 × 2.5 in

Extension Cable 5m is a 5-meter long extension cord designed to increase the distance between a power source and connected devices. It provides flexibility in equipment placement, especially in situations where the standard cable length is insufficient.



07 SEGO Spare Parts

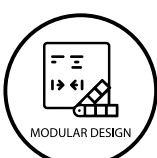

Bridge handle for HP

Weight 0.035 lbs
Dimensions 3.4 × 2.8 × 0.7 in

Buckle for foot

Weight 0.05 lbs
Dimensions 3.7 × 1.9 × 0.75 in

DC cap for VP

Weight 0.003 lbs
Dimensions 1.1 × 1.1 × 0.1 in

End block L for VP

Weight 0.12 lbs
Dimensions 4.8 × 3.9 × 0.75 in

End block R for VP

Weight 0.12 lbs
Dimensions 4.8 × 3.9 × 0.75 in

GVE Transformer 150W

Weight 1.21 lbs
Dimensions 8 × 4.1 × 1.7 in

GVE Transformer 252W

Weight 1.53 lbs
Dimensions 8.7 × 4.7 × 2.1 in

GVE Transformer 95W

Weight 0.73 lbs
Dimensions 6.6 × 4 × 1.7 in

Joint block L for VP

Weight 0.059 lbs
Dimensions 6.3 × 0.75 × 0.6 in

Joint block R for VP

Weight 0.059 lbs
Dimensions 6.3 × 0.75 × 0.6 in

LED Extension Connector

Weight 0.07 lbs
Dimensions 1.75 × 0.65 × 0.65 in

LED Stripe for SEGO 100cm

Weight 1.17 lbs
Dimensions 38 × 1.4 × 0.6 in

MP Cross

Weight 0.07 lbs
Dimensions 5 × 5 × 0.6 in

MP Support

Weight 0.04 lbs
Dimensions 4.3 × 2.9 × 1.2 in

S-Cable 1.2 meter

Weight 0.12 lbs
Dimensions 5.1 × 1.8 × 1.8 in

S-Cable 2.6 meter

Weight 0.23 lbs
Dimensions 5.1 × 1.8 × 1.8 in

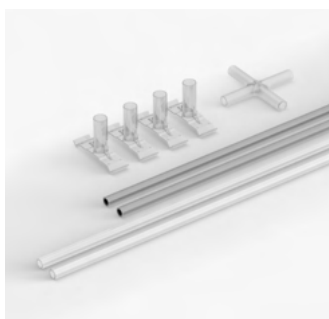
SEGO Strengthen Mid Pole Kit 200x240cm

Weight 1.9 lbs
Dimensions 47.3 × 5.1 × 5.1 in

SEGO Strengthen Mid Pole Kit 300x240cm

Weight 3.1 lbs
Dimensions 47.8 × 5.1 × 5.1 in

Slide block for HP

Weight 0.08 lbs
Dimensions 4.24 × 3 × 0.5 in

Wheely bag 1

Weight 4.8 lbs
Dimensions 47.3 × 6.5 × 12.6 in

Wheely bag 2

Weight 5.3 lbs
Dimensions 55.1 × 6.5 × 12.6 in

Y-Cable 2.6 meter

Weight 0.28 lbs
Dimensions 5.1 × 1.8 × 1.8 in

Thank you

Graphic • SEGO Basic Lightboxes • SEGO Modular Tradeshow Booths
Accessories • Spare Parts